

## LED Flat Panel

1'x4', 2'x2' & 2'x4'



### **Our Easy Install LED Flat Panel Helps Reduce Energy Use & Maintenance Costs.**

Our new thin LED Flat Panels utilize the latest technology. This means even, glare-free illumination, a 100,000-hour rated life, a 10 year warranty and a reduced heat load. Available in up to 125 lumens per watt, the Litetronics LED Flat Panel is among the most efficient in the industry.

The thin lighting surface, steel backing and aluminum assembly frame serve as a powerful heat sink. Hot spots are minimized. HVAC costs reduced and occupant comfort increased. The low overall height of the panel and driver means the product is also well suited for compact spaces and insulated ceilings.

Our LED Flat Panel offers superior ease of install. The removable driver combines an easy access splice box and convenient knock-outs so you can easily complete your wiring separate of your LED Flat Panel install. You can snap the pre-wired driver into position on the Flat Panel via a docking connector that requires no additional tools.

Available in 2'x4', 2'x2' and 1'x4' sizes and a range of color temperatures, our Flat Panel fixtures offer extreme cost savings. Additional mounting accessories provide the option to use your LED Flat Panel fixture for suspended as well as surface mount installations

#### **Benefits**

- DLC listed
- Removable driver for easy installation wiring
- Limited 10-year warranty
- Suitable for damp locations
- 0-10V dimming
- Universal 120-277V
- Emergency battery backup options
- Bug free

#### **Markets**

- Hospitality
- Healthcare
- Offices
- Warehouse
- Retail
- Schools

#### **Applications**

- Drop Ceilings
- Surface Mount\*
- Suspended Mount\*

# LED Flat Panel

1'x4', 2'x2' & 2'x4'

## Technical Product Information

**Average Rated Life:** 100,000H

**CRI:** 80

**Power Factor:** ≥0.95

**Weight:** 1x4 = 8 lbs. | 2x2 = 8 lbs. | 2x4 = 16 lbs.

**Beam Angle:** 110°

**Operating Temp.:** -4°F to 113°F

**Dimming:** 0-10V

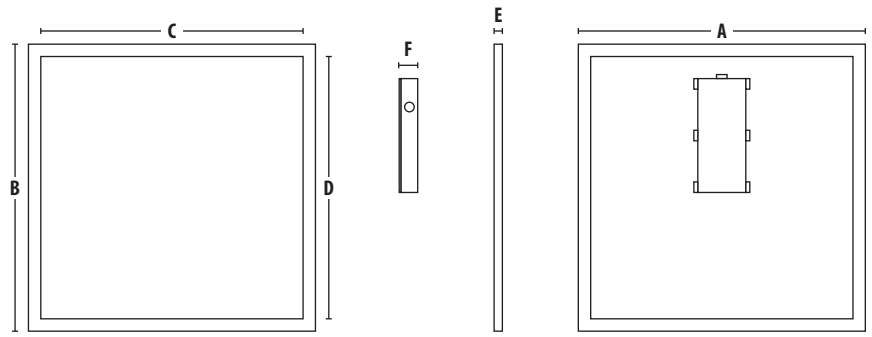

## Sizing

PART	A	B	C	D	E	F
1' x 4'	11.85"	47.5"	9.88"	45.53"	.44"	1.38"
2' x 2'	23.75"	23.75"	21.78"	21.78"	.44"	1.38"

## DLC Premium Product Specifications

TYPE	WATTS	DESCRIPTION	CCT (K)	LUMINAIRE LUMENS
1' X 4'	30	30W WHT LED FLAT PANEL 1X4 PRE 120-277V 3500K 0-10V DIM	3500	3750
		30W WHT LED FLAT PANEL 1X4 PRE 120-277V 4000K 0-10V DIM	4000	3750
		30W WHT LED FLAT PANEL 1X4 PRE 120-277V 5000K 0-10V DIM	5000	3750
2' X 2'	30	30W WHT LED FLAT PANEL 2X2 PRE 120-277V 3500K 0-10V DIM	3500	3750
		30W WHT LED FLAT PANEL 2X2 PRE 120-277V 4000K 0-10V DIM	4000	3750
		30W WHT LED FLAT PANEL 2X2 PRE 120-277V 5000K 0-10V DIM	5000	3750
2' X 4'	40	40W WHT LED FLAT PANEL 2X4 PRE 120-277V 3500K 0-10V DIM	3500	5000
		40W WHT LED FLAT PANEL 2X4 PRE 120-277V 4000K 0-10V DIM	4000	5000
		40W WHT LED FLAT PANEL 2X4 PRE 120-277V 5000K 0-10V DIM	5000	5000

## DLC Standard Product Specifications

TYPE	WATTS	DESCRIPTION	CCT (K)	LUMINAIRE LUMENS
1' X 4'	30	30W WHT LED FLAT PANEL 1X4 120-277V 3500K 0-10V DIM	3500	3000
		30W WHT LED FLAT PANEL 1X4 120-277V 4000K 0-10V DIM	4000	3000
		30W WHT LED FLAT PANEL 1X4 120-277V 5000K 0-10V DIM	5000	3000
2' X 2'	30	30W WHT LED FLAT PANEL 2X2 120-277V 3500K 0-10V DIM	3500	3000
		30W WHT LED FLAT PANEL 2X2 120-277V 4000K 0-10V DIM	4000	3000
		30W WHT LED FLAT PANEL 2X2 120-277V 5000K 0-10V DIM	5000	3000
	40	40W WHT LED FLAT PANEL 2X2 120-277V 3500K 0-10V DIM	3500	4000
		40W WHT LED FLAT PANEL 2X2 120-277V 4000K 0-10V DIM	4000	4000
		40W WHT LED FLAT PANEL 2X2 120-277V 5000K 0-10V DIM	5000	4000
2' X 4'	50	50W WHT LED FLAT PANEL 2X4 120-277V 3500K 0-10V DIM	3500	5000
		50W WHT LED FLAT PANEL 2X4 120-277V 4000K 0-10V DIM	4000	5000
		50W WHT LED FLAT PANEL 2X4 120-277V 5000K 0-10V DIM	5000	5000



# LED Flat Panel

1'x4', 2'x2' & 2'x4'

## Product Overview

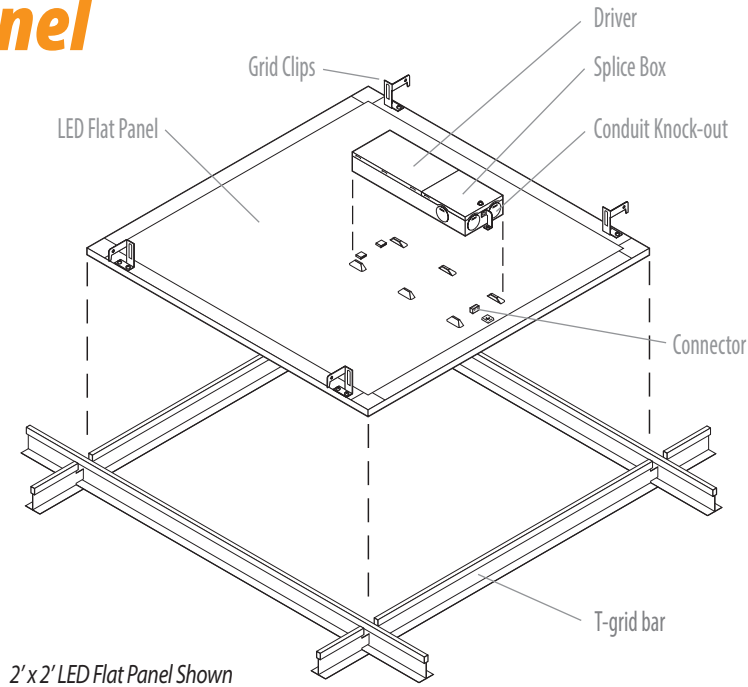

## What's included in the box with LED Flat Panel:

Installation Instructions • (1) LED Flat Panel • (1) Driver with Splice Box • (3) Wire Nuts

## Special Features for Easy Install:

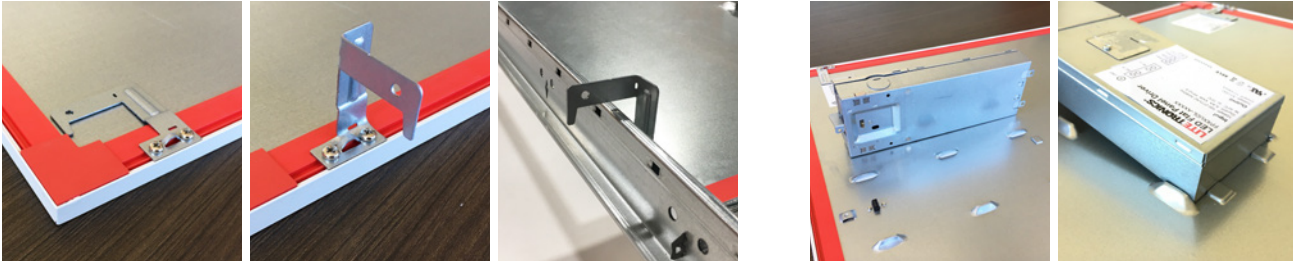

Integrated Grid Clips bend up and out. Then, when lowered into the ceiling, they catch on T-grid bar, for added support.

Driver easily snaps into place with the help of tabs and guides.

## Surface Mount Accessories (2'x2' Shown):

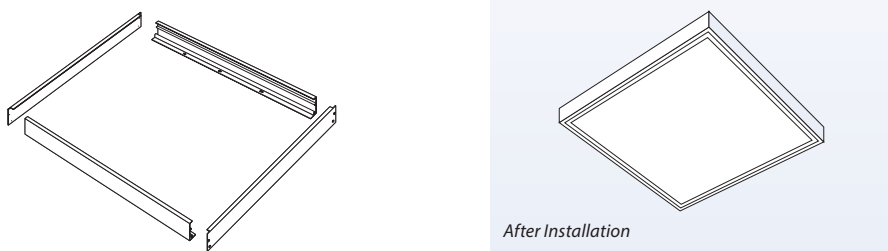

DESCRIPTION	QTY/ CASE	ACCESSORY USE
2X4 SURFACE MOUNT KIT	6	Used to mount 2x4 Flat Panels to ceiling surfaces
2X2 SURFACE MOUNT KIT	6	Used to mount 2x2 Flat Panels to ceiling surfaces
1X4 SURFACE MOUNT KIT	6	Used to mount 1x4 Flat Panels to ceiling surfaces



237 Harrison Avenue | Waukesha, WI 53186

P: 1-262-547-1111 Fax: 262-548-8882

[www.LogicalGreenSolutions.com](http://www.LogicalGreenSolutions.com)

# LED Flat Panel

1'x4', 2'x2' & 2'x4'

## Suspended Mount Accessories:

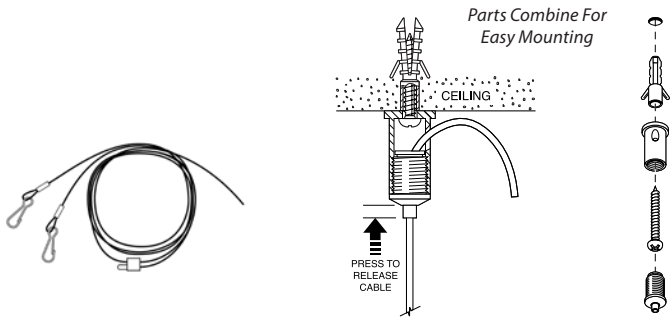

After Installation

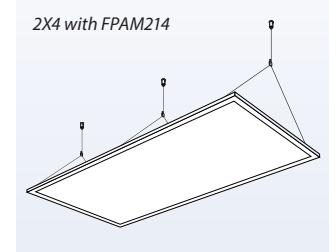
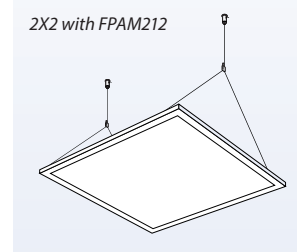

WEIGHT RATING	DESCRIPTION		QTY/ CASE	ACCESSORY USE
25 LBS	2X4 SUSPENSION MOUNT KIT		24	Suspend 2x4 Flat Panels from ceiling
25 LBS	SUSPENSION MOUNT KIT FOR 1X4 AND 2X2		24	Suspend 1x4 and 2x2 Flat Panels from ceiling



237 Harrison Avenue | Waukesha, WI 53186  
 P: 1-262-547-1111 Fax: 262-548-8882  
[www.LogicalGreenSolutions.com](http://www.LogicalGreenSolutions.com)